



Description of the Communication Protocol

for Series 4 LD ... 9LD OEM pressure transmitter from KELLER

Version 2.5



1	Introduction	3
2	Electrical Interface	3
2.1	Pinout	3
2.2	Pull-up Resistors	4
2.3	Bit Rate	4
2.4	Bus Capability	5
3	Data Frame	6
3.1	START and STOP Condition	6
3.2	ADDRESSing	6
3.3	ACKnowledge	7
3.4	STATUS Byte	7
3.5	DATA Bytes	7
4	Get Measurement Data	8
4.1	Get the digital Values	8
4.2	Interpretation of the digital Values	8
4.3	Variants to detect the End Of Conversion	10
4.4	Voltage-Time-Diagrams	11
5	Optional further Commands	12
5.1	Memory-Map of User Information	12
5.2	Recommended Slave Addresses	14
5.3	Changing the Slave Address	15
6	K-404 User Manual	16
6.1	USB-to-I2C Dongle	16
6.2	PC Application to change the Slave Address	18
7	Appendix	23
7.1	Code Examples	23
7.2	Application Notes	25
7.3	Protocol Changes	25
7.4	Firmware Versions	25
7.5	Support	25



1 Introduction

Visually the Series 4 LD ... 9 LD are like standard KELLER pressure transducers with a 5 pin interface to connect the half-open Wheatstone Bridge. But these I²C versions contain beside the pressure sensor a very tiny signal conditioner. This results in an OEM pressure transmitter with a digital interface. The "D" stands for "digital" and for "dual"; the LD-Line provides pressure and temperature information.

The most important topics regarding the communication with the Series 4 LD ... 9 LD and KELLER's unique embedded DSP core, are listed in this protocol description - especially the interpretation of the readout values.

For more information about the I²C specification please visit the NXP website and have a look at the User Manual in the documents section. I²C is a licence free standard since 2006: http://www.nxp.com/documents/user_manual/UM10204.pdf

2 Electrical Interface

2.1 Pinout

Lable	Description	Wire
SUP	1,8...3,6 V	BK
GND	GND	WH
SCL	I ² C Clock	YE
SDA	I ² C Data	BU
EOC	End of Conv.	RD

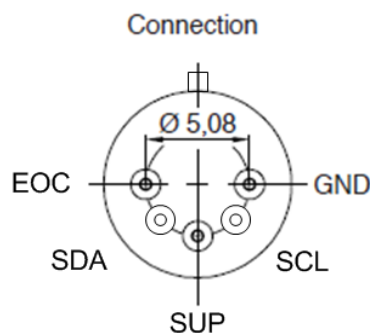

Notes

Be careful with forces occurring on the glazed pins.

- Cracks in the glass insulation causes leakage (damage)
- Forces on the pins causes output offsets

Do not touch the steel diaphragm!

Cabling

There are no special requirements to the wires or a flexible printed circuit (FPC) depending on the cross section because the current consumption is very low.

Sleep-Mode typ. 100nA

Active-Mode typ. 1.5mA (during conversion in less than 8ms, typ. 6ms)

Be careful with cabling over more than a few centimetres. The I²C-Bus is not a fieldbus and only EMC safe if the interconnections are short or screened by the surrounding housing of the whole application or a suitable cable.



2.2 Pull-up Resistors

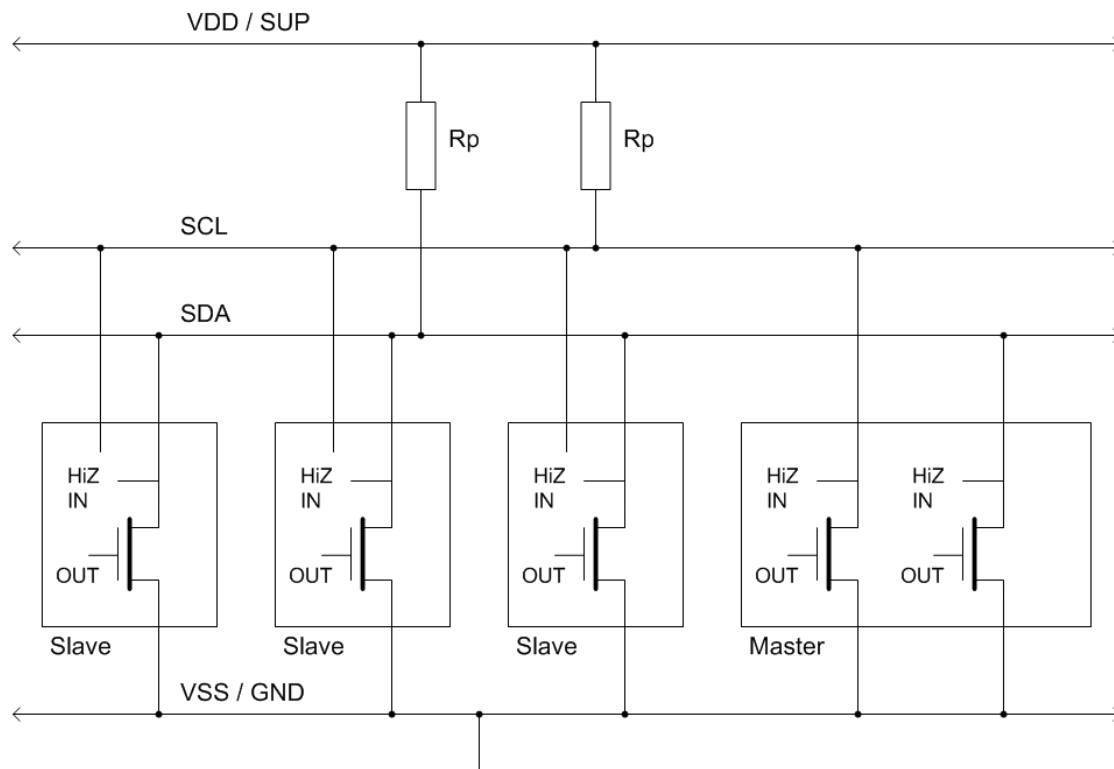

Pull-up resistors are needed at SDA and SCL. 1..10kOhm are recommended. In order to optimise the data rate or low power consumption, other resistance values are possible.

The EOC-Pin supplies an active high level in idle state and an active low level during conversion.

The SCL and the SDA lines are open drain driven. The wired-AND circuits avoid level collisions. Additional series resistors placed directly at the bus members leads to even more security.

An electric HIGH level stands for '1', a LOW level for '0' => positive Logic

Please be careful with non open drain hardware like general purpose IOs and tri-state tricks.

2.3 Bit Rate

The D-Line transmitters work over a wide range of data transfer speeds. All four modes are supported because the maximum clock frequency is 3.4MHz.

Mode	Max. Bit Rate
Standard Mode	100 kbit/s
Fast Mode	400 kbit/s
Fast Mode Plus	1 Mbit/s
High Speed Mode	3.4 Mbit/s

It is recommended to start with a low speed e.g. 50kHz - get the whole thing working – and then increase the bit rate if needed. The maximal possible speed depends also on the cable length (capacity) and the pull-up resistors.

Because the I²C interface is a synchronous serial bus, the bit rate doesn't have to be stable. The master defines the timing. That makes bit banging easy if there is no dedicated hardware integrated in the master controller.



2.4 Bus Capability

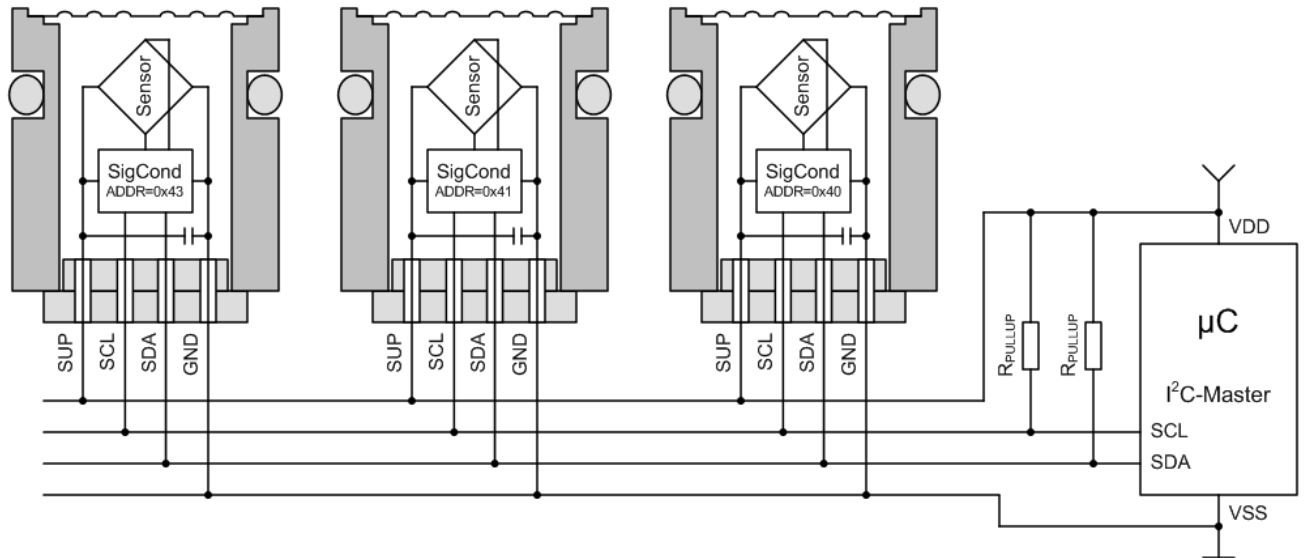

The bus capability is given by the physical (electrical) and the data link (protocol) bus layer.

On the electrical layer are only active LOW signal levels allowed. This avoids short circuit currents caused by a collision of a HIGH and a LOW level and makes clock stretching possible.

On the protocol layer addressing is needed. Therefore every slave on the same bus has to respond on a different address. The address is stored in the memory of the transmitter.

The additional EOC lines (undrawn) which signalise the End-Of-Conversion can not be coupled together without an AND gate. But there are solutions without using the EOC line or all the EOC lines can be routed independently to a parallel port of the master microcontroller.



3 Data Frame

3.1 START and STOP Condition

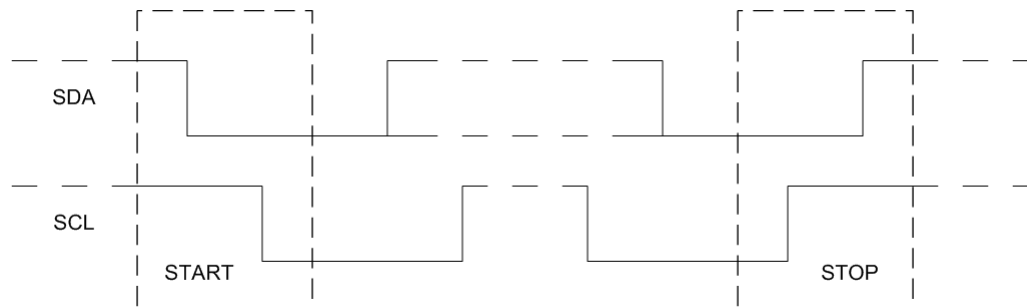

Every data frame is bordered by a start and a stop condition.

The START bit (S) is caused by pulling down SDA while SCL stays high. Then SCL has to go low before the first data bit is set. SCL is then ready for a positive edge - when the data line is valid - to trigger the receiver.

After the last transferred data bit the SCL line goes high and the STOP bit (P) is sent by releasing SDA while SCL is constantly high.

3.2 ADDRESSING

The first Byte of every data frame contains the slave address and R/W bit.

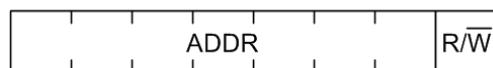

The 7 bits allow 112 bus nodes. 16 of the 128 possible addresses are reserved (0x00 .. 0x07 and 0x78 .. 0x7F). The default slave address of the D-Line transmitters is:

0x40

D-Line transmitters answer only to the address stored in the memory. There is no response to the general call address 0x00.

Examples

ADDR is 0x43: For a data transfer from the master to the slave (write) the first byte is 0x86.

ADDR is 0x47: For a data transfer from the slave to the master (read) the first byte is 0x8F.



3.3 ACKnowledge

After every transferred byte (in both directions) the receiver of the byte gives feedback with the acknowledge bit.

The slave should always confirm the bytes by an ACK (A). If the slave does not respond with a LOW level after the 8th bit, the master detects an exception (for example caused by requesting to the wrong slave address).

A NACK (N) from the master's side is not always an exception. It is also needed to terminate a read data frame.

I²C Write



I²C Read



Underlined bits and bytes come from the slave, the rest comes from the master.

3.4 STATUS Byte

Bit	7	6	5	4	3	2	1	0
Meaning	0	1	Busy?	Mode		Memory error?	Don't care	Don't care

Busy? 0 = conversion completed, 1 = busy

Mode 00 = Normal Mode, 01 = Command Mode, 1X = Reserved

Memory error? 0 = checksum okay, 1 = error

3.5 DATA Bytes

The data registers of the D-line transmitters are always 16 bit long. Before the data bytes stands always a STATUS byte.

Therefore are three possibilities to read out data useful: one, three or five bytes.

By reading one byte you just get the STATUS of the D-Line transmitter.

Reading three bytes is useful to get STATUS and the pressure information [u16] or a 16 bit register from the memory.

Reading two additional bytes (five bytes over all) is useful to get both 16 bit measurement information – pressure and temperature.

The master has to terminate a read data frame with a NACK and the obligatory STOP bit independent from the count of read bytes.



4 Get Measurement Data

Underlined bits and bytes come from the slave, the rest comes from the master.

4.1 Get the digital Values

ADDR default = 0x40

First byte is: (ADDR << 1) + 1 for Read
(ADDR << 1) + 0 for Write

1. Request Measurement (2 bytes from Master)

ADDR	W	0xAC
------	---	------

2. Wait ≥8ms or wait for EOC=1 (goes up to VDD) or check the “Busy?” flag [5] in the status byte (only 1 byte reading needed).

3. Read Measurement (1 byte from Master, 5 bytes from Slave)

ADDR	R	<u>STATUS</u>	<u>P MSB</u>	<u>P LSB</u>	<u>T MSB</u>	<u>T LSB</u>
------	---	---------------	--------------	--------------	--------------	--------------

Getting only the pressure information; it is possible to read out only 3 bytes from the slave.

4.2 Interpretation of the digital Values

The scaling of the pressure and the temperature is a simple straight line function defined by two tuples (points). This leads to the following linear equations.

P [u16]

16384	P _{@16384} resp. P_min , e.g. -1 bar PR
49152	P _{@49152} resp. P_max , e.g. 30 bar PR

The pressure range of the transmitter is stored in its memory and/or written on the associating papers.

$$P [\text{bar}] = (P [\text{u16}] - 16384) \times (P_{@49152} - P_{@16384}) / 32768 + P_{@16384}$$

The output range is ¼ to ¾ of the 16 bit output word. This way a little over- and under-pressure is measurable and the exceeding resolution of more then 30'000 point guarantee a very high resolution of 10'000 points even for the next lower standard pressure range.

T [u16]

384	-50°C
64384	150°C

The scaling goes from -50 to 150°C but the working temperature range of the transmitter is at maximum -40..110°C (depending on the order; 0..50°C and -10..80°C are the standard temperature ranges).

$$\begin{aligned} T[^\circ\text{C}] &= (\text{floor}(T[\text{u16}] / 16) - 24) \times 0.05^\circ\text{C} - 50^\circ\text{C} \\ &= (T[\text{u16}] \gg 4) - 24) \times 0.05^\circ\text{C} - 50^\circ\text{C} \end{aligned}$$

Reduce the 16 bits of the temperature information first to 12bit; the last 4 bits are anyway noise floor. This way a resolution of 1/20°C is still given.



Examples

Read Measurement (after a request by 0x80 | 0xAC and waiting for the end of the conversion)

0x81	0x40	0x4E	0x20	0x5D	0xD1
ADDR=0x40 / Read	STATUS	Pressure		Temperature	

STATUS: 0x40 means no error, just powered

Pressure: 0x4E20 = 20 000_{dec}

for a "PR-7LD / -1..10bar" transmitter: $p[\text{bar}] = (20\,000 - 16384) \times (10\text{bar} - (-1\text{bar})) / 32768 + (-1\text{bar})$
= 0.213867 bar

for a "PA-4LD / 30bar" transmitter: $p[\text{bar}] = (20\,000 - 16384) \times (30\text{bar} - 0\text{bar}) / 32768 + 0\text{bar}$
 $p[\text{bar}] = (20\,000 - 16384) \times 30\text{bar} / 32768$
= 3.31055 bar (4.31055 bar in relation to vacuum)

for a "PAA-9LD / 3bar" transmitter: $p[\text{bar}] = (20\,000 - 16384) \times (3\text{bar} - 0\text{bar}) / 32768 + 0\text{bar}$
 $p[\text{bar}] = (20\,000 - 16384) \times 3\text{bar} / 32768$
= 0.331055 bar (in relation to vacuum)

Temperature: 0x5DD1 = 24 017_{dec}

$T[^\circ\text{C}] = (24\,017 - 384) \times 0.003125^\circ\text{C} - 50^\circ\text{C}$
= 23.8531 °C (incl. noise)

Shift right by 4 : 24 017 / 16 = 1501

$T[^\circ\text{C}] = (1501 - 24) \times 0.05^\circ\text{C} - 50^\circ\text{C}$
= 23.85 °C (without 4 Bit of noise)



4.3 Variants to detect the End Of Conversion

Yellow: SCL, Blue: SDA, Red: EOC, Green: SUP, Bit Rate: 75kHz

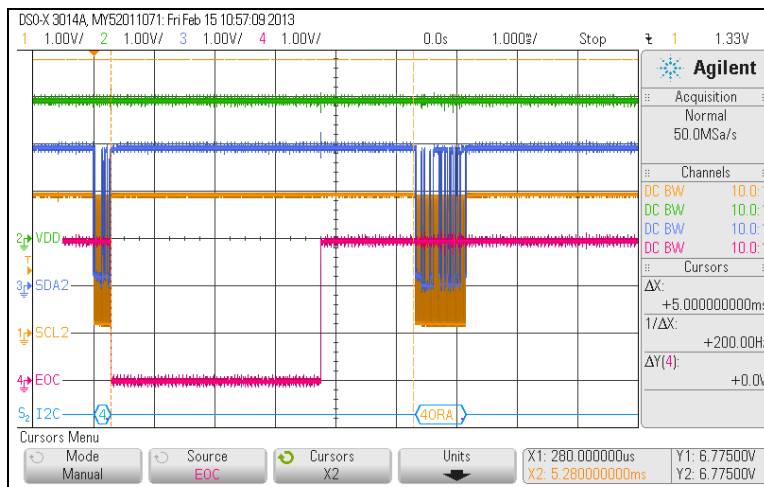

The simplest way to “detect” the end of a conversion (EOC) is to wait until the new data is definitely ready to read out. Being on the safe side; the conversion and the conditioning of the pressure and temperature value is completed after 8ms.

While the $\geq 8\text{ms}$ of waiting, the Master controller can be in sleep mode or doing some other tasks like requesting other pressure transmitters on the bus to make a new conversion.

(The graph shows a too short conversion time.)

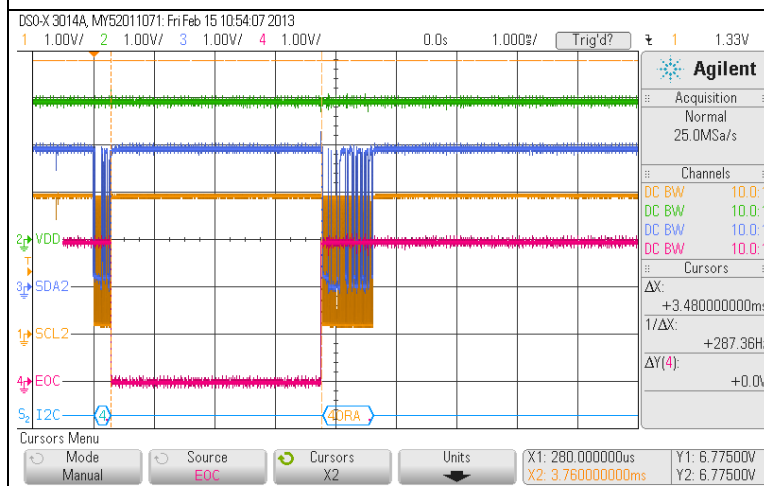

The handshake-solution, done by the additional EOC wire, is very elegant and is suitable to save time and power. The Master controller can be in sleep mode and will be awoken by an external interrupt on the positive slope of the EOC pin. Polling the level of the EOC wire is also possible.

For this solution an additional wire per transmitter is needed. It is not possible to connect all the EOC wires commonly like SCL and SDA of the bus system.

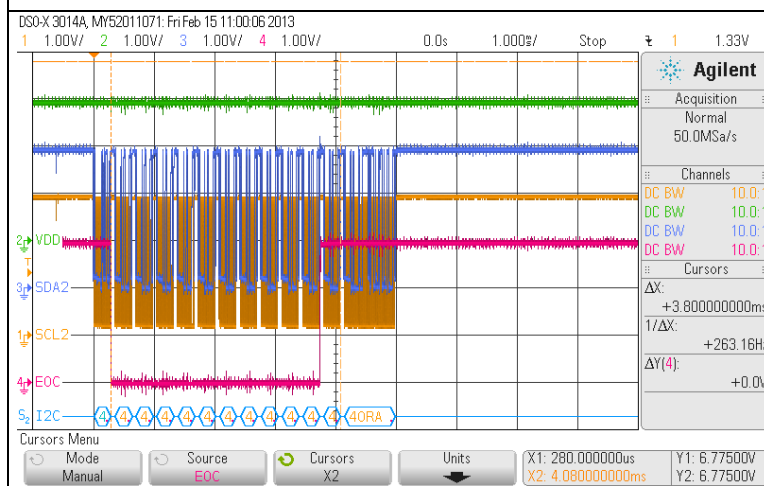

To save time without the additional EOC wire is possible by reading out the status of the pressure transmitter. There is no request needed, just a simple readout command for the first byte that contains the “Busy?” flag.

Bit	7	6	5	4	3	2	1	0
Meaning	0	1	Busy?	Mode	Memory error?	Don't care	Don't care	

Bit 6 and bit 5 (“Busy?”) will be „1“ during the conversion. At the end of the conversion bit 5 changes to “0”. Then the new data is ready to read out by additional Clocks for the pressure and temperature bytes or a new readout command to shift out the whole 5 byte data frame.

This variant effects the highest power consumption because the Master controller is nonstop busy and also the pull-up resistors are energized more often.



4.4 Voltage-Time-Diagrams

The following measurements are taken with 1kOhm pull-up resistors. In series to the master controller SCL and SDA line are 100E resistors to get a visual difference between an active LOW level from the master and from the slave. The slave is able to pull SDA hard to ground, a LOW level from the master goes only down to 10% of the supply voltage. The address of the slave is 0x00 and the bit rate 100kHz.

Yellow: SCL, Green: SDA, Red: EOC, Blue: I²C analyser

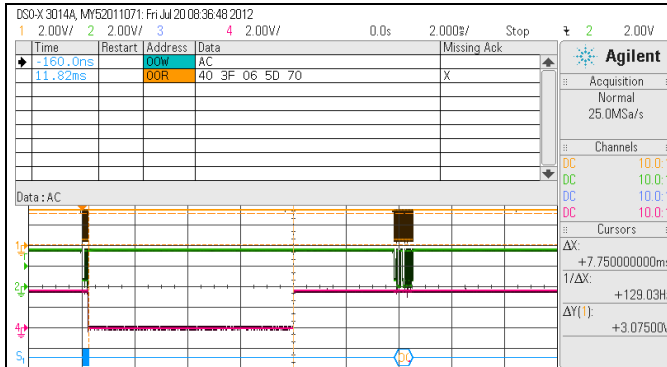

The EOC line is low for 7.75ms. The newest datasheet guarantees a conversion time below 8ms, typ. 6ms. To reach sample rates over 100 SPS it is a must to work with a high bit rate and to check the EOC line or to poll the STATUS byte.

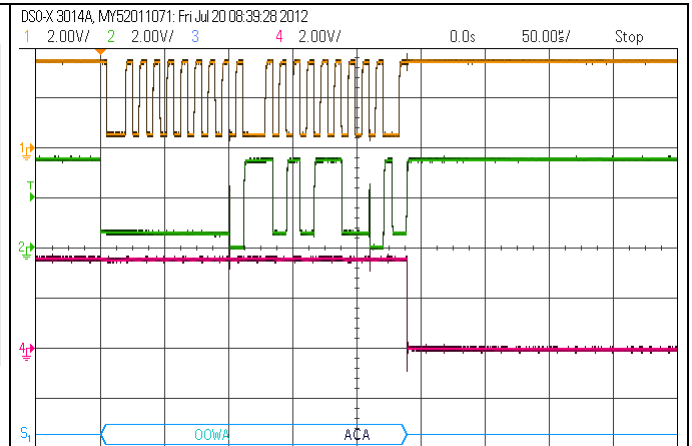

Nice to see: The ACK from the slave follows immediately to the negative edge of the 8th clock impulse (two times visible).

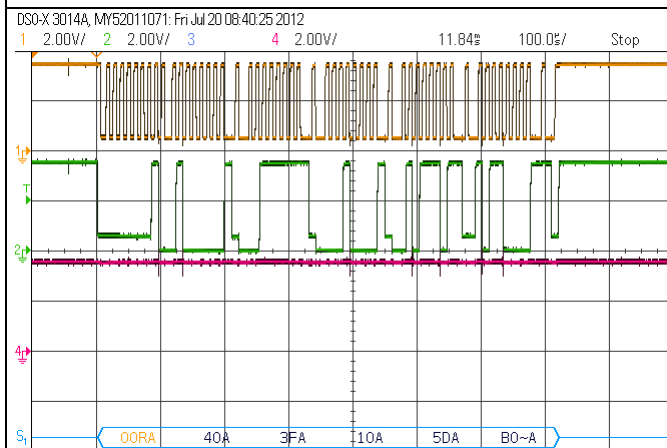

No acknowledge (NACK) from the master after reading out the 5th data byte. The "Missing Ack" that is recorded in the tables is not a mistake, it's a must.

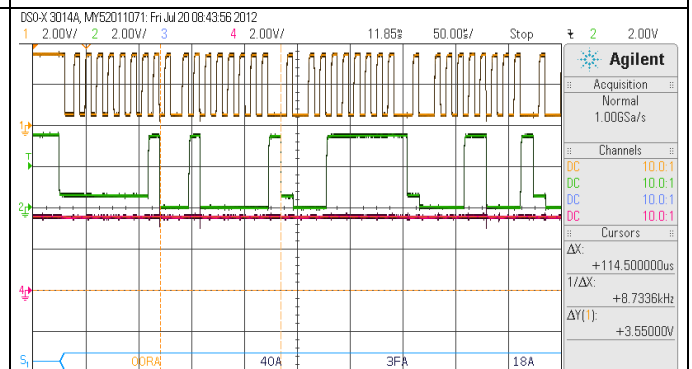

More detailed view of the readout frame: EOC is back to 3.6V. The slave ACK occurs as normal immediately after the neg. edge of the 8th clock impulse. The ACK from the master occurs with a little delay but this is allowed because the master generates the 9th clock impulse by itself at the right time.

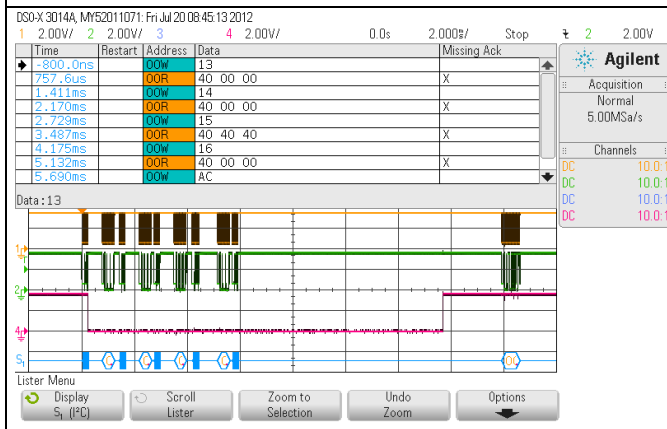

On the left side are 4 read cycles on the memory visible before the request 0xAC command occurs. In the memory cells 0x13 .. 0x16 is the scaling of the pressure output stored.

0x13 and 0x14 contain Pmin, here 0bar

0x15 and 0x16 contain Pmax, here 3bar

The table does not show the last action on the bus. 10ms after the 0xAC command follows the readout of the 5 data bytes including STATUS, pressure and temperature.

(The graph shows a too long conversion time.)



5 Optional further Commands

It is possible to read out a unique product code, the date of calibration and the scaling of the transmitter.

5.1 Memory-Map of User Information

16 bit memory cells

MTP Address	Description	Definition	Remarks
0x00	Cust_ID0	Equipment# [0..63] Bit10..15 Place# [0...1023] Bit0..9	for DB access
0x01	Cust_ID1	File# Bit0..15	for DB access
0x11	Not assigned	File# Bit16..31	presently AUX
0x12	Scaling0	Year [0..31]+2010 Bit11..15 Month [0..15] Bit7..10 Day [0..31] Bit2..6 P-Mode[0..3] Bit0..1	Y:5bit M:4bit D:5bit P:2bit
0x13	Scaling1	P_16384 [f32 (IEEE 754, single) MSWord]	Pmin [bar] als 32bit float
0x14	Scaling2	P_16384 [f32 (IEEE 754, single) LSWord]	
0x15	Scaling3	P_49152 [f32 (IEEE 754, single) MSWord]	Pmax [bar] als 32bit float
0x16	Scaling4	P_49152 [f32 (IEEE 754, single) LSWord]	

IEEE 754: single respectively float from "single-precision binary floating-point format"

P-Mode[0..3]: 0=PR, 1=PA, 2=PAA, 3=AUX

The combination of Cust_ID0 and Cust_ID1 makes a 32bit code to recover calibration data at KELLER or to have a recognition feature for data bases on the customer side.

The scaling e.g. "PR -1..10bar" is stored in Scaling0 to Scaling4 but could also be read on the associating papers. The date of calibration is an additional information that finds also place in Scaling0.

Read Memory Content:

ADDR default = 0x40

First byte is: (ADDR << 1) + 1 for Read
(ADDR << 1) + 0 for Write

1. Request Measurement (2 bytes from Master)

ADDR	W	MTP Address (0x00..0x16)
------	---	--------------------------

2. Wait for 0.6ms or check the "Busy?" flag

3. Read Measurement (1 byte from Master, 3 bytes from Slave)

ADDR	R	STATUS	Mem MSB	Mem LSB
------	---	--------	---------	---------



4. Interpretation

In the two LSBs of cell 0x12 is the pressure mode (sealed or vented gauge and zero definition) stored.

The content of cell 0x13 and 0x14 is a floating-point value that indicates the pressure in [bar] for the lower output value, 16384.

The content of cell 0x15 and 0x16 is a floating-point value that indicates the pressure in [bar] for the higher output value, 49152.

Example

MTP Address	Description	Value	Decoding
0x00	Cust_ID0	0x0415	0b000001 0000010101: 1 21 => Equipment#: 1, Place#: 21
0x01	Cust_ID1	0x0111	0b0000000100010001: 273 => File#: 273
0x11	Not assigned	0x0000	Not assigned
0x12	Scaling0	0x1574	0b00010 1010 11101 00: 2 10 29 0 => Date: 29.10.2012, Mode: PR
0x13	Scaling1	0xBF80	binary-to-float(0xBF800000) = -1.0E0
0x14	Scaling2	0x0000	- 1 bar
0x15	Scaling3	0x4120	binary-to-float (0x41200000) = 1.0E1
0x16	Scaling4	0x0000	+ 10 bar

Unique Product Code: Cust_ID1 x 65536 + Cust_ID0 = 0x01110415 = 17892373



5.2 Recommended Slave Addresses

If you want to combine more than one pressure transmitter on the same I²C bus, the slave addresses have to be unique. For this purpose the memory content of -for example- a second transmitter has to be overwritten. It is not possible to erase the content to make any possible change because the memory is based on a “one time programmable” technology, so it is only possible to add some “1”s by burning additional bit-cells. After adding 6 “1”s to the 7 bit slave address register, there is a further possibility to make changes: clearing the whole memory content by incrementation of the page counter. That gives you in minimum a second chance to choose a slave address absolutely independent from the tries before.

The conclusion is that it is not possible to change the slave address unlimited times. So it is recommended to plan the whole bus system and program the bus addresses once or in case of something unpredictable a second time.

To have more than one possibility per memory page to change the slave address, we recommend the following set off addresses.

Shot	Description	Slave-ADDR
0	1 st Transmitter, default	0x40
1	2 nd Transmitter	0x41
2	3 rd Transmitter	0x43
3	4 th Transmitter	0x47
4	5 th Transmitter	0x4F
5	6 th Transmitter	0x5F
(6)	(7 th Transmitter)	(0x7F)

With the mentioned addresses it is possible to make for example a 3rd transmitter on the bus to a 4th.

The „I²C committee” does not recommend to use addresses between 0x78 and 0x7F, so the 6th try is possible but not favoured.

The addresses 0x00 to 0x07 are also reserved and 0x00 is the „General call address“.

If you change the slave address and don't use a new memory page, the checksum can not be updated. The STATUS byte is then no longer 0x40 (only bit 6 is set), it becomes 0x44 (“Memory error?” appears) but that has no effect to the functionality of the transmitter, it just makes it impossible to detect a memory error.



5.3 Changing the Slave Address

A free choice of the slave address is difficult to write, this should only be done with the KELLER USB-to-I2C data converter in combination with the appending KELLER PC application. When using the KELLER converter and KELLER software, it becomes a simple easy to use procedure. Please ask for details if you are not already aware of these products and consider the user manual in chapter 6.

KELLER do not recommend attempting to change the slave address with the following procedure (but you can do it, so we will give the details). Using this method it is only possible to write additional "1" to the current memory page.

1. Turn off the power supply of the transmitter (a parallel resistor is useful for a proper shutdown)
2. Turn on the power supply and set the transmitter into Command-Mode by sending 0xA9 as first command:
| (ADDR <<1)+0 | 0xA9 |
3. Optionally read the actual Slave-Address from memory cell 0x02 (also possible in Normal-Mode) to get the needed information to add only one single "1" (to erase already burned "1s" is not possible in a OTP):
| (ADDR <<1)+0 | 0x02 |, wait 0.6ms, | (ADDR <<1)+1 | Status | HighByte | LowByte |
The Slave-ADDR is in the 7 LSBs. All other 9 bits should be "0".
In the Status-Byte appears an additional "1" to indicate the Command-Mode: Bit3=1; Bit4=0;
4. Set new Slave-Address in memory cell 0x02 with the write-command-offset of 0x40:
| (ADDR <<1)+0 | 0x42 | HighByte | LowByte |
The Slave-ADDR is in the 7 LSBs. All other 9 bits should be "0".
5. Optionally check/verify the new memory content by repeating step 3
6. Update the Slave-Address in the RAM in the transmitter by switching the power off and on.
Sending the Start_NOM command 0xA8 does not update the RAM.

Communicate from this moment on with the new Slave-Address.

Note: Because it is not possible to update the CheckSum over the whole memory content, the "Memory error?" flag in the Status-Byte is from now set: Bit2=1

If you want to integrate the address management into you own software environment, please ask the KELLER development department for more information about the internals of the D-Line. Copying the whole memory content to the next page is a difficult sequence. One little mistake makes the transmitter unusable.



6 K-404 User Manual

The easiest way to change the slave address of a D-Line transmitter or to check the scaling and other product information is to use KELLER's USB-to-I2C converter and the related PC-Software.

6.1 USB-to-I2C Dongle

The "K-404 T" is equipped with a plug to connect directly to the 5pol TO header.



The 9LD on the TO plug is not part of the converter

The cable on the I2C side is less than 30cm (one foot) long. For EMC reason please extend the connection on the USB side if needed.

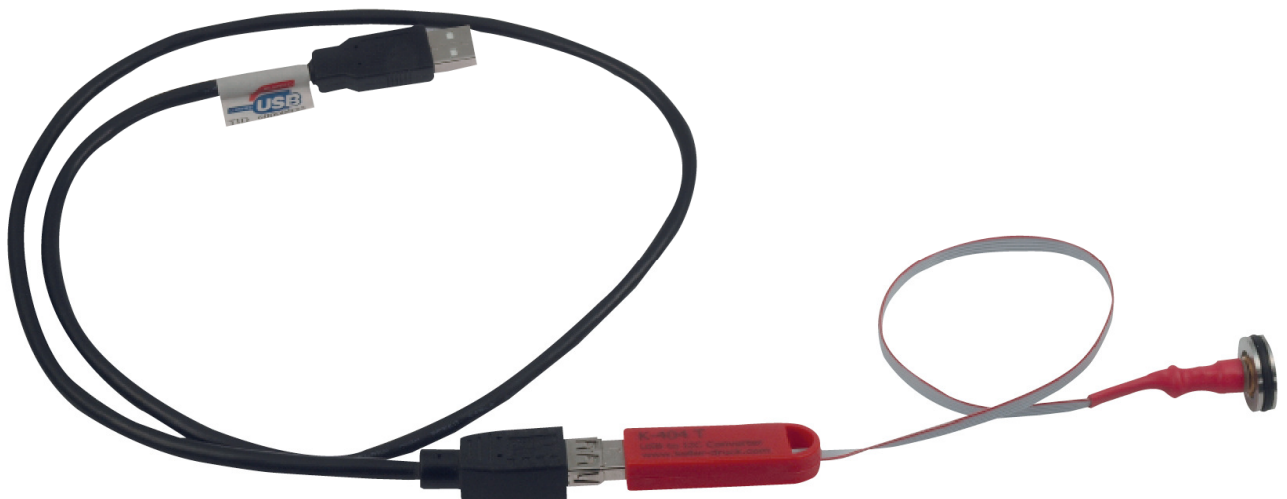

The K-404 converter is short circuit protected. The EOC-Pin is not connected and SDA and SCL are pulled up to the 3,3V supply by internal resistors. Please be careful by connection an oscilloscope with relation to earth because there is no galvanic isolation built in the converter.



Connect the dongle first to the computer and wait until the operating system has installed the driver, before you start the related application. This runs automatically.

You will find the converter than under “Control Panel \ Devices and Printers” as “IO-Warrior56”.

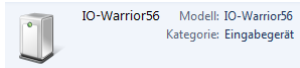

It is a standard “Human Interface Device”, therefore you don't have to install a specific driver.

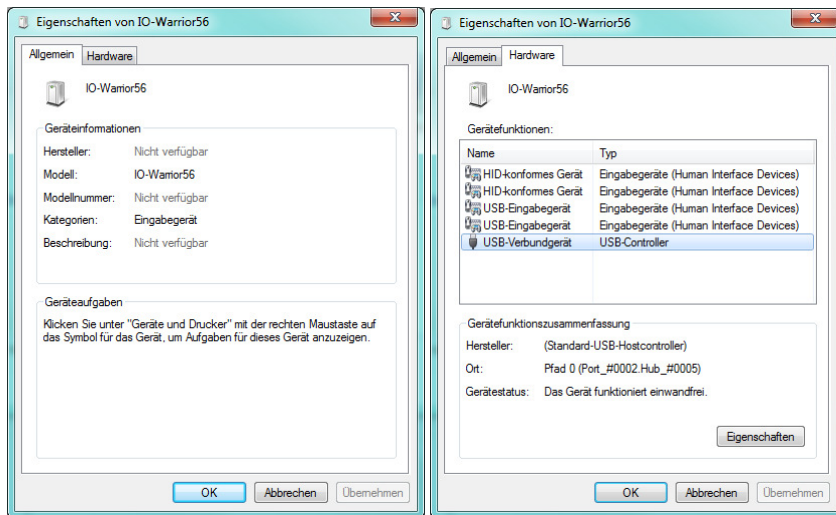



6.2 PC Application to change the Slave Address

First, install the latest “D-Line Address Manager” application on your computer. You find it on the software CD (coming with the K-404 converter) or it can be downloaded free of charge at www.keller-druck.com.

The “D-Line Address Manager” is a “one button” application. It’s important to connect the USB-to-I2C converter first to the PC and start the application afterwards. It begins autonomous to scan the I2C bus and shows the values of the found D-Line transmitter without any click. Hot-plugging of the transmitter is possible.

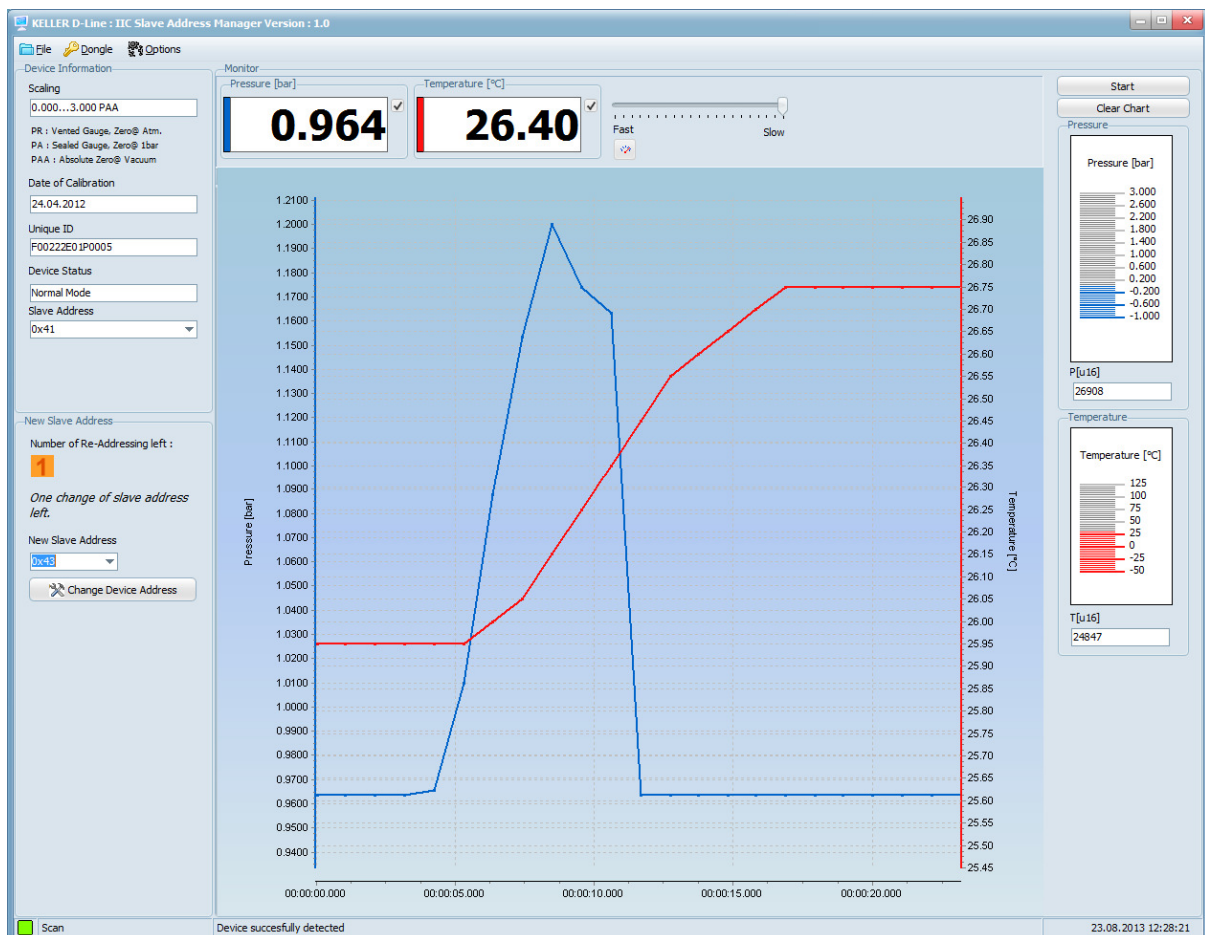

The important information and the key function “Change Device Address” are displayed on the left skyscraper frame, the rest of the surface is “bonus material”.

Please select as first step your language in the pull-down menu “Options” under “Settings”:

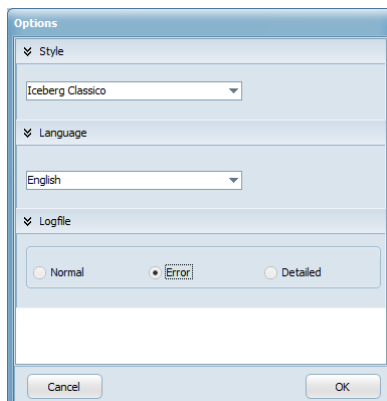

The application remains your “Style”, “Language” and “Logfile” selection.



Main functions

The “D-Line Address Manager” does scan the I2C bus by checking the response (acknowledge) to every possible Slave Address from 0x00 to 0x7F. After finding a working transmitter, the “User Information” (see chapter 5.1) is read out and displayed in decoded form. The most important information is the pressure range to new the scaling of the 32768 output range.

Device Information

Scaling
0.000...3.000 PAA

PR : Vented Gauge, Zero@ Atm.
PA : Sealed Gauge, Zero@ 1bar
PAA : Absolute Zero@ Vacuum

Date of Calibration
24.04.2012

Unique ID
F00222E01P0005

Device Status
Normal Mode

Slave Address
0x41

Pressure [bar] 0.963

Temperature [°C] 25.85

At the same time the actual measurement results are shown in the “Monitor” frame – converted to [bar] and [°C].

The unsigned 16 bit values – who are really transferred – on the bus – are also always refreshed:

P[u16] 26906

T[u16] 24741

New Slave Address

Number of Re-Addressing left :
1

One change of slave address left.

New Slave Address
0x43

Change Device Address

Confirmation

Do you wish to continue with assigning new slave address: 0x43 to device ?

No Yes

The reason to offer this communication tool is to make the changing of the slave address as easy as possible. The memory technology of the D-Line transmitters is one time programmable (OTP). There are 4 pages of one time programmable memory. That means, that it is a must to do the copy job ‘right first time’, the “D-Line Address Manager” can do all of that for you.

Please be careful with changing the address, because with every change the number ‘Re-Addressing’ remaining will count down, until there are no more address changes possible. (New LD Transmitters will normally be delivered with either 2 or 3 address changes remaining.)

The change request has to be confirmed by the shown popup window that displays the chosen new address again.

After doing the change a further popup window appears. It shows the whole memory content and can also be opened with the pull-down menu “Dongle” under “Show Memory Map”. The content is just to your information. After closing it the “Device Information” frame will be updated with the new slave address.



Bonus functions

The “Monitor” frame is only a simple tool to get a first impression of the transmitters output. The USB-Dongle and this graph function are not developed for application use. The D-Line transmitters are OEM products and have to be connected to the customer’s microcontroller.

The three additional buttons and the slider for the sampling rate are the only important control elements for the monitor. Click simply on [Start] and the graph begins to roll. The scaling of the axis is set automatically to a reasonable range.

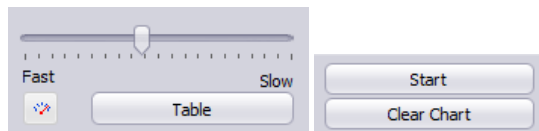

Slow: 1 SPS, Fast : ca. 30 SPS (depends on the performance of the computer system)

The “Pressure” and the “Temperature” bars are synchronous updated. The “levels” of the bars are displayed in figures in the “Pressure [bar]” and the “Temperature [°C]” text box. The captions show the over the I2C bus transferred unsigned 16 bit figures.

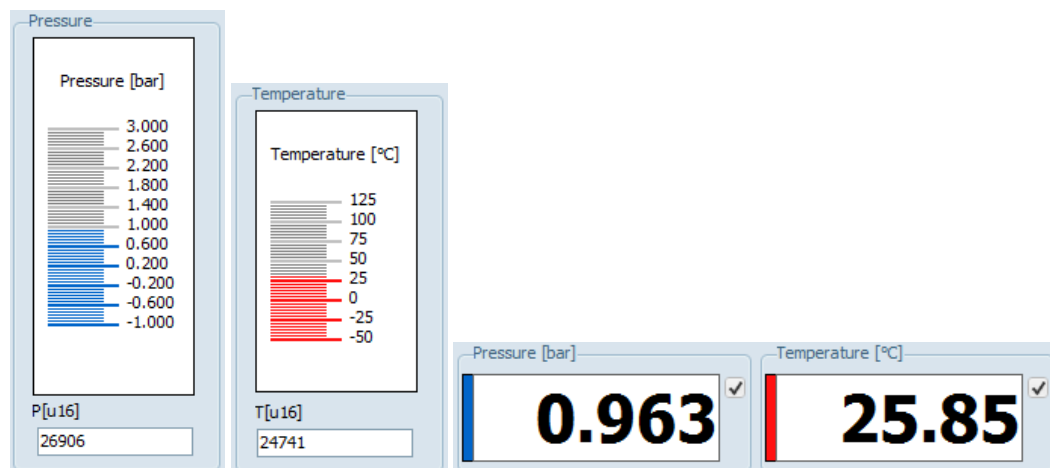

The scaling of a D-Line transmitter is always in [bar] and [°C]. There are two ways to convert the figures to other units.

1. Conversion of the conditioned figures for example from [bar] to [psi]
2. Conversion of the scaling endpoints and direct conditioning from [u16] to e.g. [psi]

It is very interesting to know the unsigned 16 bit figures for the conversion according to point 2.



By dragging the mouse over the left boundary of the graph, the following menu appears.

The screenshot shows a configuration window titled 'Axis' with three tabs: 'Axis', 'Chart Color', and 'Axis Color'. The 'Axis' tab is active. It contains two sections: 'Left Axis' and 'Right Axis'. Each section has a 'Left Axis' or 'Right Axis' label, a 'Max' value, a 'Min' value, an 'Increment' value, a 'Decimals' dropdown, and a 'Show GridLines' checkbox. The 'Automatic' checkbox is checked for both axes. The 'Left Axis' section has a blue square icon, and the 'Right Axis' section has a red square icon. A 'Reset' button is located next to the 'Increment' field in both sections.

Axis	Automatic	Max	Min	Increment	Decimals	Show GridLines
Left Axis	<input checked="" type="checkbox"/>	1.2111	0.9335	0.0001	4	<input checked="" type="checkbox"/>
Right Axis	<input checked="" type="checkbox"/>	26.95	25.45	0.05	2	<input checked="" type="checkbox"/>

This functionality makes it possible to zoom in or out and change the scaling of the axis. To make manual changes the check box have to be deactivated and the entering of a new figure be confirmed with the Enter key (not by just clicking to the next box).



By pressing the [Table] button the following pop-up window will appear (valid from software version 1.2).

The screenshot shows a window titled "Table" with the following settings:

- Scaling: 0.000...30.000 PA
- Date of Calibration: 28.04.2014
- Unique ID: F00481E01P0016
- Device Status: Normal Mode
- Slave Address: 0x40
- Number of Re-Addressing left: 3
- Initial: hof
- Description: asdfghjkl
- Relative Time Axis:

Buttons: Copy Data, Save, and an Open icon.

	Date	Time	P[u16]	P [bar]	T[u16]	T [°C]
1	02.06.2014	11:24:14.755	16401	0.016	24207	24.40
2	02.06.2014	11:24:15.265	16399	0.014	24214	24.45
3	02.06.2014	11:24:15.765	16400	0.015	24212	24.45
4	02.06.2014	11:24:16.285	16399	0.014	24207	24.40
5	02.06.2014	11:24:16.745	16399	0.014	24210	24.45
6	02.06.2014	11:24:17.205	16399	0.014	24210	24.45

The table shows the data stored in the background of the monitor chart. Choose "Relative" or "Absolute Time Axis" before starting the data acquisition.

The "Table" pop-up window is developed to export measured data in text format. There are two ways to do that.

1. [Copy Data] stores the data on the clipboard.
2. [Save] opens the File-Explorer to store the data in the CSV format to a non-volatile memory like a hard drive.

The "Open" icon  just opens the File-Explorer to brows and open saved files (this is not an import function).

The stored data contains the time stamps, pressure and temperature values and a heading section with "Initial", "Description" and the full "Device Information" including the pressure range, the "Unique ID" and so on:

```

Description                asdfghjkl

Initial                    hof

Scaling                    0.000...30.000 PA
Date of Calibration        28.04.2014
Unique ID                  F00481E01P0016
Device Status              Normal Mode
Slave Address              0x40
Number of Re-Addressing left 3

Date      Time            P[u16] P [bar]      T[u16] T [°C]
02.06.2014 11:24:14.755    16401 0.016      24207 24.40
02.06.2014 11:24:15.265    16399 0.014      24214 24.45
02.06.2014 11:24:15.765    16400 0.015      24212 24.45
02.06.2014 11:24:16.285    16399 0.014      24207 24.40
02.06.2014 11:24:16.745    16399 0.014      24210 24.45
02.06.2014 11:24:17.205    16399 0.014      24210 24.45

```



7 Appendix

7.1 Code Examples

Still under construction

7.1.1 Read Measurement: Header-File

```
////////////////////////////////////  
// constants  
  
#define SDA_OUT      TRISDbits.TRISD5    // RD5 is SDA (without MSSP)  
#define SDA_OD      LATDbits.LATD5  
#define SDA_IN      PORTDbits.RD5  
#define SCL_OUT     TRISDbits.TRISD6    // RD6 is SCL (without MSSP)  
#define SCL_OD      LATDbits.LATD6  
  
#define cZI_Pmin    0                    // fix coded or read out from the userMEM  
#define cZI_Pmax    30                  // fix coded or read out from the userMEM  
  
////////////////////////////////////  
// global variables  
  
_F32 ZI_pressare;    // Variable for pressure value in [bar] as single (IEEE 754)  
_F32 ZI_temperature; // Variable for temperature value in [°C] as single (IEEE 754)  
_U8 ZI_status;      // Variable for 8 bit status  
_U8 ZSSCget[5];     // Array to receive data frame  
  
////////////////////////////////////  
// prototypes global functions  
  
_U8 get_PnT_GPIO(_U8);  
_U8 get_PnT_MSSP(_U8);
```



7.1.2 Read Measurement: C-File

```

////////////////////////////////////
// global functions

_U8 get_PnT_GPIO(_U8 ADDR) {
    _U8 ZSSCerror=0;
    _F32 Pmin, Pmax;
    union {
        _F32 floatingpoint;
        _U32 twotimesU16;
    } cast;

    //init IOs ( better once before while(1) ) //init
    SDA_OD=0; // LOW if output active: Open Drain
    SCL_OD=0; // LOW if output active: Open Drain

    SDA_OUT=1; // release SDA => pull-up resistor makes HIGH level
    SCL_OUT=1; // release SCL => pull-up resistor makes HIGH level

    //read the scaling //read
    I2C_write_1Byte(ADDR,0x13);
    Delay10TCYx(150); // 0.4us x 10 x 150 = 0.6ms
    I2C_read_xByte(ADDR,3);
    cast.twotimesU16 = (((_U32)(ZSSCget[1]))<<24) + (((_U32)(ZSSCget[2]))<<16);
    I2C_write_1Byte(ADDR,0x14);
    Delay10TCYx(150); // 0.4us x 10 x 150 = 0.6ms
    I2C_read_xByte(ADDR,3);
    cast.twotimesU16 += (((_U32)(ZSSCget[1]))<<8) + ((_U32)(ZSSCget[2]));
    Pmin= cast.floatingpoint;

    I2C_write_1Byte(ADDR,0x15);
    Delay10TCYx(150); // 0.4us x 10 x 150 = 0.6ms
    I2C_read_xByte(ADDR,3);
    cast.twotimesU16 = (((_U32)(ZSSCget[1]))<<24) + (((_U32)(ZSSCget[2]))<<16);
    I2C_write_1Byte(ADDR,0x16);
    Delay10TCYx(150); // 0.4us x 10 x 150 = 0.6ms
    I2C_read_xByte(ADDR,3);
    cast.twotimesU16 += (((_U32)(ZSSCget[1]))<<8) + ((_U32)(ZSSCget[2]));
    Pmax= cast.floatingpoint;

    //request new conversion //read
    if(I2C_write_1Byte(ADDR,0xAC)){return 0x91;}

    //wait for new conversion result //read
    Delay100TCYx(200); // 0.4us x 100 x 200 = 8ms

    //read the results out //read
    if(I2C_read_xByte(ADDR,5)){return 0x91;}

    //interpret integer values //read
    ZI_status = ZSSCget[0]; // [U8]
    ZI_pressure = (_F32) ( (((_U16)(ZSSCget[1]))<<8) + (_U16)(ZSSCget[2]) ); // p[U16]
    ZI_temperature = (_F32) ( (((_U16)(ZSSCget[3]))<<8) + (_U16)(ZSSCget[4]) ); // T[U16]

    ZI_pressure = (ZI_pressure-16384) * (Pmax-Pmin) / 32768 + Pmin; // p[bar]
    ZI_temperature = ((((_U16) ZI_temperature)>>4)-24) * 0.05 - 50; // T[°C]

    return ZSSCerror;
} // end of _U8 get_PnT_GPIO(_U8 ADDR)

```



7.2 Application Notes

Coming as soon as possible

7.3 Protocol Changes

- **Document Version 2.0**, 7. December 2012:
Many chapters with basic information to the I²C interface added, the Version 1.0 was a preliminary version with only KELLER specific descriptions. Changed the default "Slave Address" from 0x00 to 0x40.
- **Document Version 2.1**, 15. February 2013:
Changed the "Conversion Time" from 10ms to 4ms. New Graphics to show the faster sampling and the lower (shorter) current consumption.
- **Document Version 2.2**, 05. November 2013:
Mainly the chapter "K-404 User Manual" added. Further slight revisions for a better understanding, but no technical changes.
- **Document Version 2.3**, 10. March 2014:
Changed the "Conversion Time" from 4ms to 6ms. This is the worst case - including variation over the whole temperature range of -40...110°C and all manufacturing tolerances.
The wait time for "read memory" is also increased from 0.5ms to 0.6ms
- **Document Version 2.4**, 02. June 2014:
Added: "Export" function of the "K-404 User Manual" where the PC application is described.
- **Document Version 2.5**, 20. October 2014
Changed again the "Conversion Time" from 6ms what is a typical value to 8ms for more reserve. 8ms have never been measured but latest simulations claim this worst case value.

7.4 Firmware Versions

The Firmware is fixed in the Silicon (ROM-Version) and can't be changed by KELLER. A few settings and the content definition of the "Customer-Memory" are the only free parameters but there are no plans to change anything.

Version Year.Week	Date of Production	Major Changes
36CI1CH 12.29	since 2012	Base Version with temperature PGA settings for -40..110°C
36CI1CK 14.13	since April 2014	Base Version with temperature PGA settings for -40..110°C and temperature sensor settings for lower pressure dependency

7.5 Support

We are pleased to offer you support in implementing the protocol. Use our free PC-software "D-Line Address Manager" in combination with the K-404 USB-to-I²C-Dongle for a first communication with the transmitter and for the configuration of non-default "Slave Addresses". Please visit our website <http://www.keller-druck.com> to check updates and further application notes.

KELLER AG für Druckmesstechnik

St. Gallerstrasse 119
CH-8404 Winterthur
Tel: ++41 52 235 25 25

<http://www.keller-druck.com>